

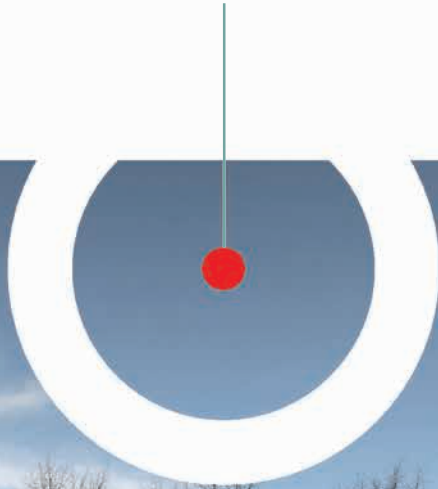

ARBOS



PRODUCTS CATALOGUE

Tractors, Precision planters, Fertilisers, Sprayers

EN



PRODUCTS CATALOGUE
ARBOS

COMPANY PROFILE

High-tech, environmentally sensitive, uncompromising design: ARBOS, the new brand which is ambitiously taking on the world market, is proceeding apace to complete its full product line, adding a complete, efficient and cutting-edge range of agricultural equipment to its range of tractors. ARBOS industrial design guidelines are clearly identifiable:

- ITALIAN TRADITION
- CUTTING-EDGE DESIGN
- ENVIRONMENTALLY SENSITIVE
- A PASSION FOR DESIGN



ARBOS has inherited the values of a long-standing and glorious Italian brand, bringing its strengths up to date, taking advantage of significant economies of scale, focusing on excellence in design and bringing everything together with an original, award-winning style*. The prerequisites for success are all present and are actively pursued with commitment and conviction, aiming at reaching a level of quality which alone can guarantee long-lasting and all-encompassing success. This is what we call "Techno - Green" approach, the cornerstone of our corporate philosophy.

Now the road has finally been paved and the new, rapidly evolving full-line product range, entirely manufactured in our two production plants in San Vito al Tagliamento and Carpi, is making a powerful advance on the domestic and international markets.

All models stand out for their comfort, practicality, style, excellent performance, green credentials and ease of use: Italian design and manufacturing has never been so smart, mixing spot-on design, execution and respect for the surrounding environment.

All this with a keen eye towards reducing purchasing, running and maintenance costs.

We are a blend of expertise, tradition and modernity.

We are ready for the challenges that today and tomorrow may throw at us.

We are fast yet careful, innovative yet grounded.

We are ARBOS.

* Red Dot Winner 2017



Tractors



Orchard/Vineyard tractors



Sprayers



**Pneumatic seed drills
minimum till & no-till**

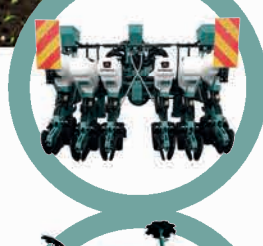

Vacuum precision planters



Seed drills wit power harrow



Fertilizer sprader



Subsoiler

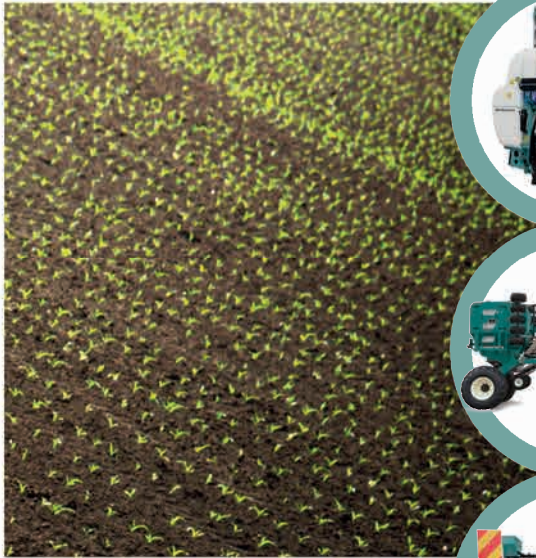

5000 SERIES

- 4 cyl 3400 cc TIER IV FINAL ENGINE
- Modular 5-speed transmission providing 3 gear ranges - Global and Advanced
- Four-pillar high-visibility cab
- Power lift with up to 4400 kg capacity and 110 l/min hydraulic system

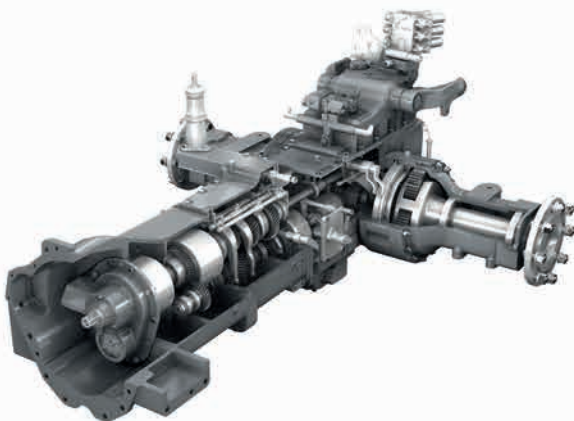

MODULAR TRANSMISSION IN MANY CONFIGURATIONS

The challenge faced by ARBOS designers was definitely not an easy one: design a transmission which is simple yet efficient, modern and relentless without affecting the easiness of use and costs. The result is clear to see: an "accessible" transmission, in line with current technical solutions which is sturdy and reliable in all conditions, as demonstrated during many rigorous field tests. The basic design was developed in two different configurations: Global, Advanced.

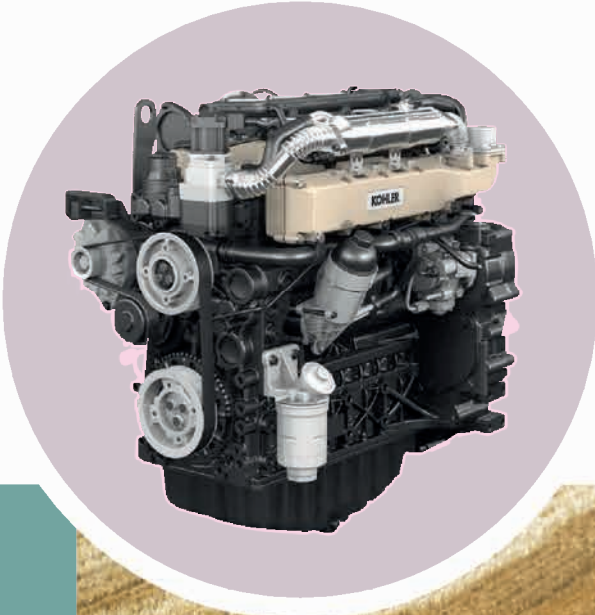

DIESEL of the year 2015

For the 5000 Series we couldn't just settle for any engine: we wanted one which is innovative, efficient, fuel saving and 100% reliable. We found it: the Kohler 3404 TCR SCR Tier IV F, four cylinders with 3400 cc, outstanding in the agricultural engines sector. No wonder it was nominated "Diesel of the Year" 2015. Today the ARBOS 5000 range offers three models from 100 to 130 HP, with maximum power of up to 136 HP and 95% of torque available between 1300 and 1800 rpm. One of the many exclusive features of these engines is the compact SCR system (with integrated DOC) installed on the exhaust: the result is a bonnet with tapered, encircling lines, elegant and distinctive, practical for a reduced turning radius.



KOHLER 3404 TCR SCR

- 4 cylinders 3,400 cc Tier IV f
- Max. power 136 HP (95% available at 1900 rpm)
- Max. torque 500 Nm at 1400 rpm
- 95% of Max. torque available from 1300 to 1800 rpm
- Starting torque 410 Nm and 36% torque increase
- Specific consumption 205 g / kWh



CAB: CAR-STYLE COMFORT

Stylish, comfortable, practical: the interior of ARBOS 5000 cab resembles a car, designed for well-being and ergonomics. It is ideal for long working days, successfully combining visibility, comfort and maximum safety.

Perfect pressurisation, reduced noise level, a microclimate that is comfortable and the same in all seasons and at all times of day.

All of this plus an easily accessible, comfortable driving position.

The extensive 360° glass surface (forward visibility angle 42° up, back 30° down) guarantees exceptional visibility and facilitates operations with the front loader and implements connected to the back.

The cab design is based on a cutting-edge engineering approach, with a structure that distributes stresses over the entire surface, making it safer and optimising the weight/power ratio, thanks to a weight that is one third lower than traditional solutions.

The thin roof profile also reduces the tractor's overall height and makes it easier to gauge dimensions where access may be difficult.

Elegance, comfort, visibility and safety: this product is hard to beat!



INTERIORS: TRULY ERGONOMIC

Easy man-machine interaction - in terms of position, load and levers travel: this is the base design concept of ARBOS 5000 cab. The reverse shuttle under the steering wheel (mechanical-synchronised or hydraulic) is handy and practical both with the front loader and in bunker silos, like the levers for the gears, the lift and auxiliary control valves, always within reach. The electro-hydraulic buttons for the diff lock and 4WD engagement allow immediate and instinctive manoeuvring operations. In the cab, amongst the many interesting solutions, comfort is enhanced by the adjustable steering column (double adjustment: angle and height) with a 3-spoke steering wheel and power steering. The light, heating and air conditioning controls are rationally laid out on the dashboard. The powerful climate control unit (completely under the bonnet, with a short and highly efficient circuit), the outlets and the special curve of the windows, optimise air circulation, giving uniform air conditioning, without sudden bursts of hot or cold air. The 5000 Series is available with a traditional analog display or with a more modern 7 inch TFT digital display, having a simple, customisable interface.

ARBOS 5130



reddot award 2017
winner



TECHNICAL SPECIFICATIONS

		ARBOS 5100	ARBOS 5115	ARBOS 5130
ENGINE				
Model		Tier IV Final		
Cylinders/Displacement	N°/cm ³	4/3404		
Aspiration		Turbo intercooler		
Injection system		2000 bar Common Rail		
Valves		16 valves		
Max. homologated power (2000/25/CE)	hp/KW	110/81	122/90	136/100
Nominal engine speed	rpm	2200		
Max. torque	Nm	470	480	500
Max. torque engine speed	rpm	1400	1400	1400
Cooling		Liquid-Oil - Gas (EGR)		
Engine control		Electronic		
Air cleaner		Dry with safety cartridge and dust ejector		
Silencer		Underhood with exhaust on cab upright		
After treatment system		DOC+ SCR integrated on rear side pillar		
Ad-Blue fuel tank capacity	l	25		
Fuel tank capacity	l	160		

TRANSMISSION GLOBAL				
Clutch		13" double dry clutch, hydraulically operated		
Gearstep		5		
Range		2		
Creeper		OPT		
Speed	FWD+REV	30 + 30 (2 speed Powershift underload)		
Max. speed		50 kph limited by electronic regulator to 40 kph* at rated engine speed and economy engine speed (1840 rpm)		
Shuttle		Mechanical shuttle with lever under steering wheel		
4WD		Electrohydraulic engagement		
Differential lock		Limited slip 50% auto; 100% diff lock with electrohydraulic engagement		

TRANSMISSION ADVANCED				
Clutch		WET clutch		
Gearstep		5		
Range		2		
Creeper		OPT		
Speed	FWD+REV	45+15 (3 speed Powershift underload)		
Max. speed		50 kph limited by electronic regulator to 40 kph* at rated engine speed and economy engine speed (1840 rpm)		
Shuttle		Powershuttle		
4WD		Electrohydraulic engagement		
Differential lock		Limited slip 50% auto; 100% diff lock with electrohydraulic engagement		

Rear P.T.O				
Clutch		WET clutch		
Speed	rpm	540-1000 or 540E-1000		
Operation		Mechanical operated with pushbutton		

BRAKES AND STEERING				
Braking system		hydrostatically operated, wet disks on rear wheels, 4WD engagement		
Trailer braking		hydraulic braking system pneumatic braking system		
Hydrostatic steering		STD		
Steering angle		55°		

5000 SERIES

		ARBOS 5100	ARBOS 5115	ARBOS 5130
FRONT AXLE				
Type		Heavy duty		
Front ballast		13 x 40 kg case type weights (total 520 kg)		
Front fenders		Dynamic		
HYDRAULIC LIFT				
Rear lift		Mechanical with Easylift / electronic rear lift		
Maximum lifting capacity	kg	4.400 kg (with external cylinder)		
Pump delivery	l/min	Gear pump total 110 l/min 70 l/min dedicated to implements		
Auxiliary hydraulic remote valves	Ways	2 / 3 / 4 remote valves + flow diverter (tot 4)		
3 point linkage (link arms and top link)		Cat II arms with quick adjustment, hydraulic top link		
Front lift		Maximum lifting capacity 2000 kg Quick ballast 850 kg		
DRIVING POSITION				
Cab features		Original sound-proofed (72 dBA), with silent block mounted platform, high visibility roof with rounded glass, up to 8 worklights (4 rear + 4 front) + telescopic rear-view mirrors		
Cab conditioning		Air conditioning		
Instruments		TFT 7" digital display		
Driver's seat		Mechanical suspension, safety belt Pneumatic suspension, safety belt		
DIMENSIONS AND WEIGHTS: with rear tyres				
Rear		540/65 R34	600/65 R38 (W18L*38)	600/65 R38 (W18L*38)
Front		440/65 R24	440/65 R28 (W14L*28)	440/65 R28 (W14L*28)
Max. length at link arms	mm	4.249	4.299	4.299
Width (min - max)	mm	1916-2348	1916-2348	1966 - 2538
Max height at cab	mm	2.644	2.756	2.756
Ground clearance	mm	452	524	524
Wheelbase	mm	2.347	2.397	2.397
Front track (min - max)	mm	1559-2013	1559-2013	1559-2013
Rear track (min - max)	mm	1436-1868	1436-1868	1366-1938
Weight with cab (W/out ballast)	kg	4.200	4.600	4.600



6200

The natural evolution of the range, Series 6000, completes the “white and green” product offer: the 6000 (from 140 to 200 hp) offers the same excellent performance of the entire ARBOS range, with a particular focus on operational requirements of medium difficulty. The look? In line with the ARBOS family feeling, of course – fresh and elegant, a breath of fresh air in the somewhat predictable panorama of the traditional brands.

Extra large ARBOS-style cab. Maximum ergonomics and comfort, usual visibility and solidity



Range from 140 to 200 hp with hydraulic reverse shuttle.

110 l/min load-sensing hydraulic system and electronic power lift



TECHNICAL DATA

ENGINE		
Cylinders / hp		6 cylinder, 140 - 200 hp
Injection system		2000 bar common rail
TRANSMISSION		
Type		30+30 with Hi-LO 60+15 with 4 PWS
Shuttle		Hydraulic shuttle
4WD		Electro-hydraulic DIFF-lock and 4WD
HYDRAULICS		
Lifting capacity	kg	6200
Pump delivery		110 l/min closed centre
Hydraulic remote valves		4 remote valves
DRIVING POSITION		
Cab		Fixed cab
Seat		Pneumatic seat
DIMENSIONS AND WEIGHTS		
Wheelbase	mm	2700
Weight	kg	6000
Rear tyre		650/65R38

7260

Powered by a tireless and frugal 6-cylinder engine (from 220 to 260 hp), the Series 7000 uses an "implement powershift" transmission which offers the driver a smooth, efficient and relaxing performance. The cab is an operator's dream, with maximum comfort and minimum noise combined with ample space and above-average visibility.



6-cylinder high-performance, low-consumption engine

Excellent versatility and performance with all applications thanks to the implement powershift system: 4 PWS stages for each gear designed to optimise even the most demanding jobs

TECHNICAL DATA

ENGINE		
Cylinders / hp		6-cylinder 220-260 hp
Injection system		2000 bar common rail
TRANSMISSION		
Type		30+30 with Hi-LO 60+15 with 4 PWS
Shuttle		Hydraulic shuttle
4WD		Electro-hydraulic DIFF-lock and 4WD
HYDRAULICS		
Lifting capacity	kg	9200
Pump delivery		160 l/min closed centre
Hydraulic remote valves		4 remote valves
DRIVING POSITION		
Cab		Fixed cab
Seat		Pneumatic seat
DIMENSIONS AND WEIGHTS		
Wheelbase	mm	3000
Weight	kg	7500
Rear tyre		710/60R42

3040 3050



- Engine from 38 to 48 hp
- 12 + 12 Gearbox with fast reverse (Additional 4 fast rev speeds)
- Italian style
- Multifunctional

SPECIALIZED

3040 - 3050 are the range designed by ARBOS for a wide variety of specialistic uses: work in the open fields, between the rows of vineyards and orchards, in greenhouses and nurseries as well as in all the many transport jobs required in farms and for professional ground care. ARBOS 3040 - 3050 are the answer for those who need a versatile, multifunction machine that possesses all the strong points of an ARBOS tractor: compact size, sturdiness and reliability.

		3040	3050
WEIGHTS AND DIMENSIONS			
Length (min - max)	mm	2849	2949
Width (min - max)	mm	1309-1500	1309-1500
Height to safety frame	mm	1885-1940	1309-1500
Height to cab (min - max)	mm	2090-2180	2090-2180
Ground clearance (min - max)	mm	300+316	300+316
Wheelbase	mm	1623	1723
Front track (min - max)	mm	964-1152	964-1152
Rear track (min - max)	mm	980-1134	980-1134
Minimum turning radius with brakes	m	3,1	3,2
Weight with safety frame	kg	1440	1475
Weight with cab	kg	1610	1645
TYRES			
Rear - Front (standard)		280/85R20 - 200/70R16	280/85R20 - 200/70R16
		360/70R20 - 11.0/65x12"	360/70R20 - 11.0/65x12"
		38/14.00x20 - 27/8.50x15	38/14.00x20 - 27/8.50x15

		3040	3050
ENGINE			
Type		Lombardini LDW1603 step 3A	Lombardini LDW 2204 step 3A
Power rating	kW(hp)	28/38	35,3/48
Nominal rate	rpm	2800	
N° Cylinders	n°	3 aspirated	4 aspirated
Cooling		water	
Displacement	cc	1649	2199
Torque reserve		9%	8%
Tank capacity	l	45	
TRANSMISSION			
N° Speeds		12+12 with reverse shuttle + Fast Reverse (4 RM)	
Main clutch		9" dry disc	
Reverse Shuttle		Synchronized	
Rear differential lock		Mechanical	
Speed	Km/h	30	
BRAKES AND STEERING			
Type of brakes		Oil cooled multiple plate type with mechanical actuator	
Type of steering		Hydrostatic	
Steering angle		55°	
REAR PTO			
Type		Independent at 540/1000 rpm, clockwise rotation; synchronized with gearbox speeds, anti-clockwise rotation	
Clutch		Dry disc type	
Control		Mechanical	
FRONT PTO (Optional)			
Type		Independent at 1000 rpm anti-clockwise rotation	
Clutch		Electromagnetic	
Control		Electric	
MID PTO (Optional)			
Type		Independent at 2000 rpm	
Clutch		Dry disc type	
Control		Mechanical	
REAR POWER LIFT			
Type		Hydraulic up and down lifter with position and draft control	
Lifting capacity	kg	1800	
3 point hitch		Class 1N	
FRONT POWER LIFT (Optional)			
Type	l	Hydraulic up and down	
Lifting capacity	kg	350	
3 point hitch		Class 1N	
HYDRAULIC CIRCUIT			
Pump flow rate	l	33	
Rear hydraulic control valves		n. 2 SCV (single unit) double acting with recovery	
Front hydraulic control valves (Optional)		n. 3 SCV (single unit)	
DRIVER'S AREA			
Platform		Integral platform on liquid silicon silent block	
Safety frame		yes	
Cab		GL 12 FULL GLASS	
Instruments		Analog	
Driver's seat		On elastic suspensions	
Tow hook		B/CEE type	

4060 F 4080 F



4060 F PRO 4080 F PRO



The ARBOS 4060 F - 4080 F and ARBOS 4060 F - 4080 F PRO models are the perfect answer to the needs of professionals who work in vineyards and orchards: power and manoeuvrability, reliability and performance make these tractors the ideal partners for working in the often difficult conditions of specialist growing. The key strength of these models is their compact size.

- The shortest wheelbase in their category
- Exclusive, patented gearbox with dual power system
- Minimised turning radius
- Maximum stability and grip thanks to their perfectly balanced weight

- Compact wheelbase
- Exclusive, patented gearbox with dual power system
- Driving comfort: platform on “silent-blocks” and “overview” cab with A/C
- Excellent power-weight ratio and balance
- Approved for 40 km/h use

TECHNICAL DATA

ENGINE		
Cylinders / kW / hp		VM 3 Cyl - 35kW / 48HP / 4 Cyl 55kW 75 HP
Model		3 Cyl Tier IIIA / 4 Cyl Tier IIIB Turbo
Intake		Direct injection
TRANSMISSION		
Type		Dual Power 16+8, 8+8 transmission with lateral levers
Shuttle		Mechanical Reverse Shuttle
Differential lock		4WD and Mechanical DIFF-lock
LIFT AND HYDRAULIC SYSTEM		
Lifting capacity	kg	2300
Pump	l/min	38 open centre
Rear mechanical distributors		3
DRIVER AREA		
Version		Semi-platform
DIMENSIONS AND WEIGHTS		
Wheelbase	mm	1690-1831
Weight	kg	1900
Rear tyre		360/70R20
Width (min-max)	mm	1364-1748 1364-1794

TECHNICAL DATA

ENGINE		
Cylinders / kW / hp		VM 3 Cyl - 41kW / 56HP / 4 Cyl 55kW 75 HP
Model		Tier IIIB Turbo
Intake		Direct injection
TRANSMISSION		
Type		Dual Power 16+8, 8+8 transmission with lateral levers
Shuttle		Mechanical Reverse Shuttle
Differential lock		4WD and Mechanical DIFF-lock
LIFT AND HYDRAULIC SYSTEM		
Lifting capacity	kg	2300
Pump	l/min	38 open centre
Rear mechanical distributors		3
DRIVER AREA		
Version		Full platform/cab suspended on silent-block mounts
DIMENSIONS AND WEIGHTS		
Wheelbase	mm	1690-1854
Weight	kg	1900 (platform)
Tyres		360/70R20
Width (min-max)	mm	1290-1766 1290-1770

- Maximum traction and grip thanks to its low centre of gravity
- Version with extra-low “low profile” cab starting from 180 cm
- Driving comfort: platform mounted on variable viscosity “silent-blocks”
- More versatile than an isodiametric tractor, offering better performance than a tracked model, excellent for on-road travel
- Perfectly balanced weight

SERIE 4000 Q

4090Q - 4100Q - 4110Q



TECHNICAL DATA

ENGINE

VM 4 Cylinder Tier III B
 4090Q: 59 kW / 80 hp
 4100Q: 67 kW / 91 hp
 4110Q: 75 kW / 102 hp

DPF + IGR

TRANSMISSION

24+12 4-speed transmission providing 3 gear ranges + mini gear reducer (20%)

Mechanical shuttle

4WD and Electro-hydraulic DIFF-lock

HYDRAULICS

Lifting capacity 2500 Kg
 Electronic power lift (Opt)

Pump capacity 100 l/min (39+61) open centre up to 3 rear mechanical distributors up to 3 front electro-hydraulic distributors

DRIVING POSITION

Platform / Pressurised cab

SIZE AND WEIGHT

Wheelbase: 1923 mm

Weight: 2275 kg (Plat)

Tyres: 420/65R20

Width (min-max): 1591-1876 mm

The 4000Q series is a class of tractors apart, without equals on the market. The bold sloping design of the body, the reduced turning radius, the large and nearly isodiametric wheels of the four-wheel drive system and the powerful engine make the 4000Q series the ideal machine for working among the rows of orchards and vineyards, with their limited clearance, height and manoeuvring space and generally steep and rugged terrain. The compact frame, characterised by a weight distribution of 50% on the front axle and 50% on the rear, makes it possible to keep the centre of gravity low and close to the centre of the machine and to completely transfer the drive power to the ground. This makes it possible to operate safely even when using very heavy equipment and on extremely steep slopes.

- Hydraulic circuit capacity 39+61 litres
- Optimally balanced weight
- Maximum versatility: F - manoeuvrable and agile
AF - sturdy and compact
- Driving comfort: platform on "silent-blocks" and "pressurised" cab with A/C

SERIE 4000 F

4090F - 4100F - 4110F

SERIE 4000 AF

4090AF - 4100AF - 4110AF



A "little" machine for orchards and vineyards with more than 100 horsepower? The 4000 F and 4000AF Series (turbo intercooler, four-wheel drive, platform mounted on silent-blocks and a cab with a 360-degree view and air conditioning) will give you no cause to wish for a larger tractor. Balanced, compact, tough and tireless, these are the ideal companions for working worry-free, and there are 6 versions, so that you can find one that EXACTLY suits your needs.

TECHNICAL DATA

MOTORE

VM 4 Cyl Tier IIIB
4090 F/AF: 59 kW / 80 CV
4100 F/AF: 67 kW / 91 CV
4110 F/AF: 75 kW / 102 CV

DPF + IGR

TRASMISSIONE

Cambio 24+12 4 marce per 3 gamme + mini riduttore (20%)
Inversore meccanico
4WD e DIFF-lock Elettroidraulico

IDRAULICA

Capacità di sollevamento 2500 Kg
Sollevatore elettronico (Opt)
Portata pompa 100 l/min (39+61) a centro aperto
fino a 3 distributori meccanici posteriori
fino a 3 distributori elettroidraulici anteriori

POSTO GUIDA

Piattaforma / Cabina pressurizzata

DIMENSIONI E PESI

Passo: 1973 mm / 1990 versione AF
Peso: 2375 Kg (Plat)
Gomma: 360/70R24 / 360/70R28 versione AF
Largh. (min-max): 1404-1830 mm

SERIE 4000 E

4070E - 4080E - 4090E - 4100E

- Range with 3 and 4 cylinders up to 102 hp
- Maximum grip
- 16+16 transmission with synchronised shuttle
- Weight 2325 Kg



TECHNICAL DATA

ENGINE

VM 3 cylinder 45 kW 61 hp - 52 kW 71 hp

VM 4 cylinder 60 kW 81 hp - 68 kW 92 hp

Tier IIIB

DPF + IGR

TRANSMISSION

16+16, 12+12, 8+8

Mechanical shuttle

Electro-hydraulic DIFF-lock

HYDRAULICS

Lifting capacity 2000 Kg

Pump capacity 55 l/min open centre up to 4 rear mechanical distributors (3+1)

DRIVING POSITION

Plat

SIZE AND WEIGHT

Wheelbase: 1550 mm

Weight: 2275-2325 kg

Tyres: 320/70R20

Width (min-max): 1335-1575 mm

Standing sturdily on the identical wide and low wheels of their 4WD systems, the isodiametric tractors from the 4000E Series are the ideal solution for working safely and securely in the most difficult conditions, thanks in part to the minimised turning radius of their new tapered bodies.

Now, with their new 4 cylinders delivering up to 100 hp, these machines have never been so powerful, so reliable, so ARBOS.

SPRAYERS

MBS EVO

MBS EVO

ARBOS MBS mounted sprayers are available with three different sizes of tank, with nominal capacities of 800, 1000 and 1200 L respectively. They are all equipped with a 120 L rinse tank and a 20 L personal wash tank. All sprayers are equipped with a high-resistance steel frame, which has gone through a process of cataphoresis and then been painted with a powder coating, making it suitable for liquid fertilisation treatments. The spray booms operate using a hydraulic mechanism, with working widths of 12, 15, 16 and 18 m.

They are equipped with aluminium arms with protected sprays inside. Hydro-pneumatic shock-absorbing system and pendulum self-levelling system equipped with shock-absorbing springs with automatic hydraulic locking system.

Self-lubricating bushings

Sprayer bar with articulations with self-lubricating bushings.



Rinse tank

Polyethylene tank containing clean water for rinsing, 120 L capacity.

Main spray tank

Main spray tank in high-density polyethylene, 800/1000/1200 L (nominal).

Personal wash tank

Personal wash tank in high-density polyethylene, 20 L.



Nozzles TRIGET

Fan-spray nozzles, dual fan-spray nozzles and nozzles for liquid fertilisation – ASJ and TEEJET.



Movement

Independent opening of the right arm, left arm, alignment corrector and lift.

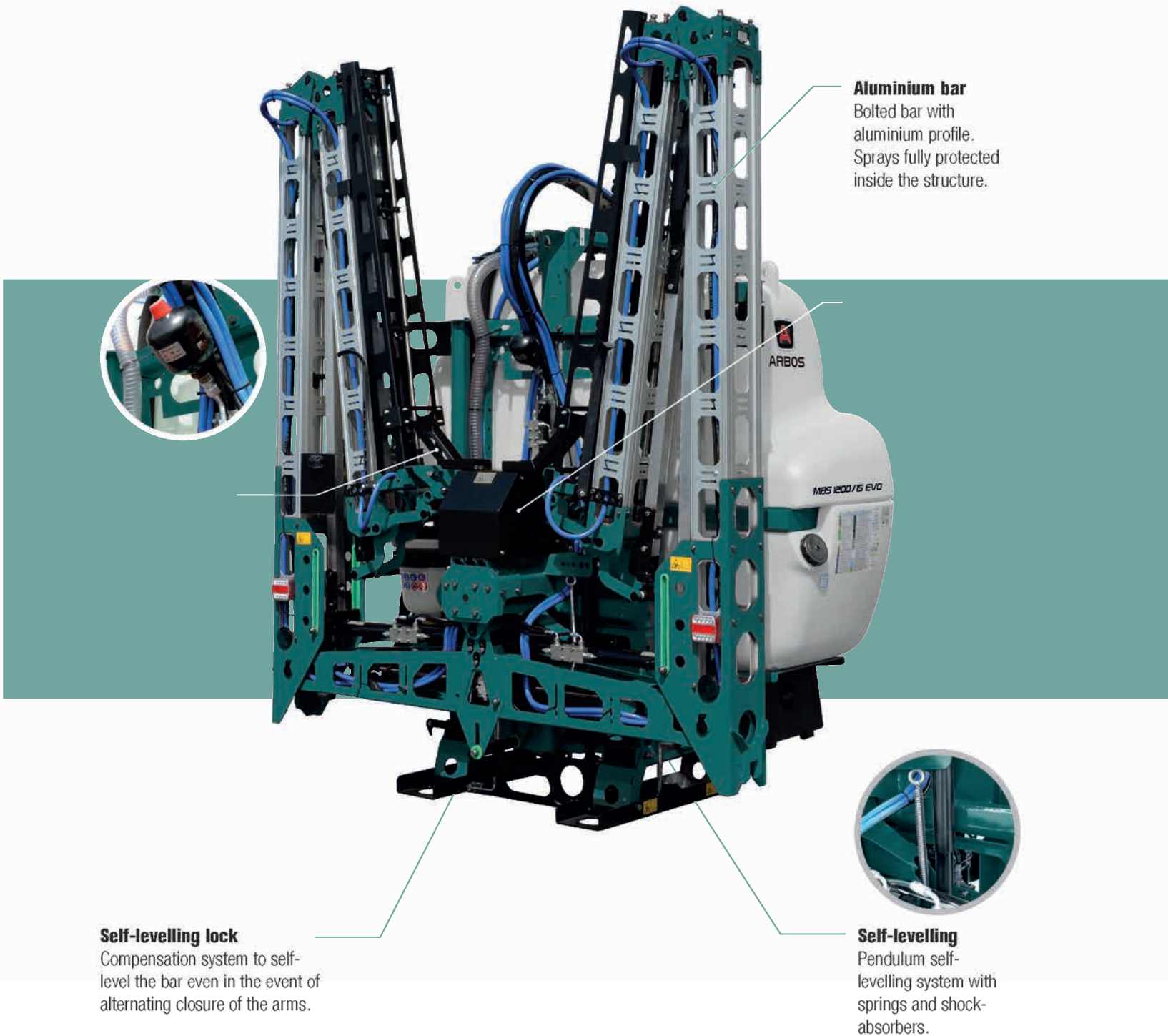

Aluminium bar

Bolted bar with aluminium profile. Sprays fully protected inside the structure.

Self-levelling lock

Compensation system to self-level the bar even in the event of alternating closure of the arms.

Self-levelling

Pendulum self-levelling system with springs and shock-absorbers.



Boom: 12 m, 5 sections, number of nozzles 6 - 4 - 4 - 4 - 6

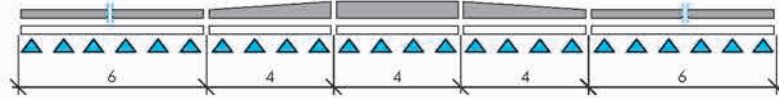

Boom: 15 m, 5 sections, number of nozzles 8 - 5 - 4 - 5 - 8

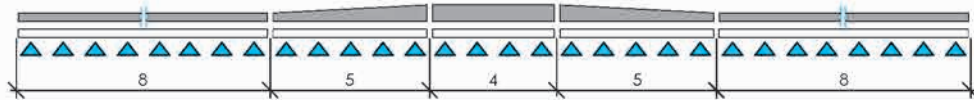

Boom: 16 m, 5 sections, number of nozzles 9 - 5 - 4 - 5 - 9

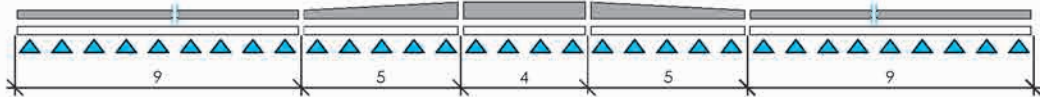

Boom: 16 m, 7 sections, number of nozzles 5 - 4 - 5 - 4 - 5 - 4 - 5



Boom: 18 m, 5 sections, number of nozzles 7 - 9 - 4 - 9 - 7

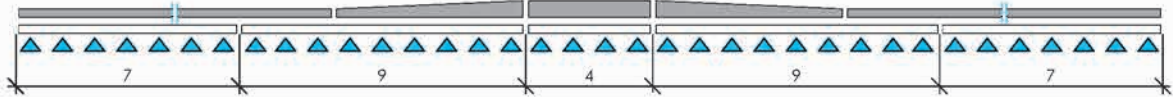

Boom: 18 m, 7 sections, number of nozzles 5 - 5 - 6 - 4 - 6 - 5 - 5

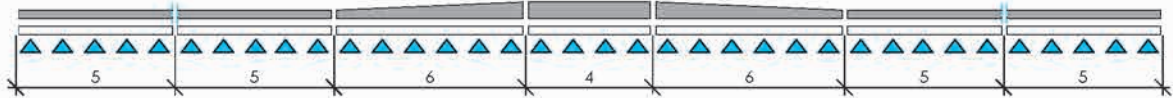

MBS EVO Mounted sprayers

The ARBOS MBS EVO mounted sprayers consist of a main spray tank, available in three different nominal capacities: 800/1000/1200 L. The hydraulic boom is available in widths of 15, 16 and 18 m.

This boom works particularly well on the edge of a field or when manoeuvring in tight fields, reducing damage to crops to a minimum.



MODEL	CAPACITY NOMINAL	CAPACITÀ EFFECTIVE	BOOM	BOOM SECTIONS	FLOW NOMINAL PUMP	SIZE. (AXBXC) 	WEIGHT
	(L)	(L)	(m)		(L/min)	(cm)	(kg)
MBS EVO 800	800	894	12	5	168	245 x 270 x 160	700
MBS EVO 800	800	894	15	5	168	245 x 270 x 160	875
MBS EVO 800	800	894	16	5	168	245 x 320 x 160	890
MBS EVO 800	800	894	16	7	168	245 x 320 x 160	900
MBS EVO 1000	1000	1077	15	5	168	245 x 270 x 160	880
MBS EVO 1000	1000	1077	16	5	168	245 x 320 x 160	900
MBS EVO 1000	1000	1077	16	7	168	245 x 320 x 160	910
MBS EVO 1000	1000	1077	18	5	168	245 x 320 x 160	915
MBS EVO 1000	1000	1077	18	7	168	245 x 320 x 160	925
MBS EVO 1200	1200	1311	15	5	168	245 x 270 x 160	900
MBS EVO 1200	1200	1311	16	5	168	245 x 320 x 160	920
MBS EVO 1200	1200	1311	16	7	168	245 x 320 x 160	925
MBS EVO 1200	1200	1311	18	5	168	245 x 320 x 160	935
MBS EVO 1200	1200	1311	18	7	168	245 x 320 x 160	940

PNEUMATIC SEED DRILLS

MINIMUM TILL & NO-TILL

Tank

Seed and fertiliser tank with loading platform. Total capacity 3000 L. (AS-F Version: 2000 L for seed, 1000 L for fertilizer).

Blower

Hydraulic blower for pneumatic seed transportation (40 L/min).



Seed and fertilizer metering unit

Volumetric and independent seed and fertilizer metering unit with divided distribution for each seeding row.



Road transport wheels

Low pressure transport wheels
600/50-R22.5 (AS 450)
700/50-R22.5 (AS 600).

Compression wheels

Compression roller to adjust depth, with
17x8.00-R8 low-pressure wheels in
correspondence with every coulter.

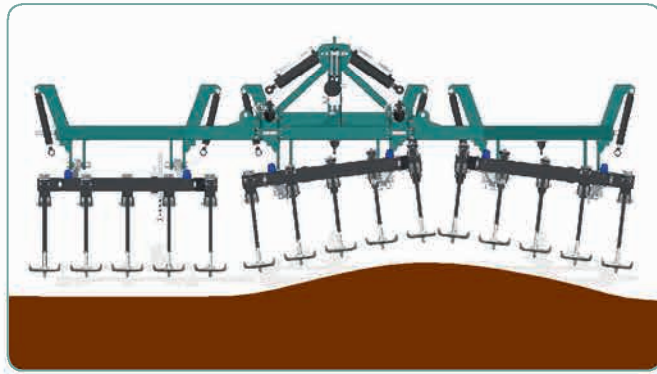

Planting unit carriers

Planting units fitted on independent, floating carriers. The system allows you to follow the edge of the land, uniformly distributing the load via a hydraulic system.



Planting unit

Optimal planting units distance, on 5 ranks. Clearance from the ground of 600 mm allowing optimal flow of the crop residue.

Tractor linkage

3-point hitch, II and III cat., with rotation joint.

Tool bar

Foldable frame for transportation on the road. Transportbreite weniger als 3,0 m.

AS-UST Pneumatic seed drills minimum till & no-till

The AS-UST Air Seeders - Under Surface Seeding Technology are developed for conservation tillage sowings of all kind of winter cereals, OSR, forage seeds and cover crops.



MODEL	N° OF ROWS	ROW SPACING MIN (cm)	TOOL BAR (cm)	WEIGHT (kg)	POWER REQUIRED (hp)	CAPACITY	
						SEED (l)	FERTIL
AS 450	15	30	290/450	3600	130-150	3000	-
AS 600	20	30	300/600	4450	170-200	3000	-
AS-F 450	15	30	290/450	3650	130-150	2000	1000
AS-F 600	20	30	300/600	4500	170-200	2000	1000

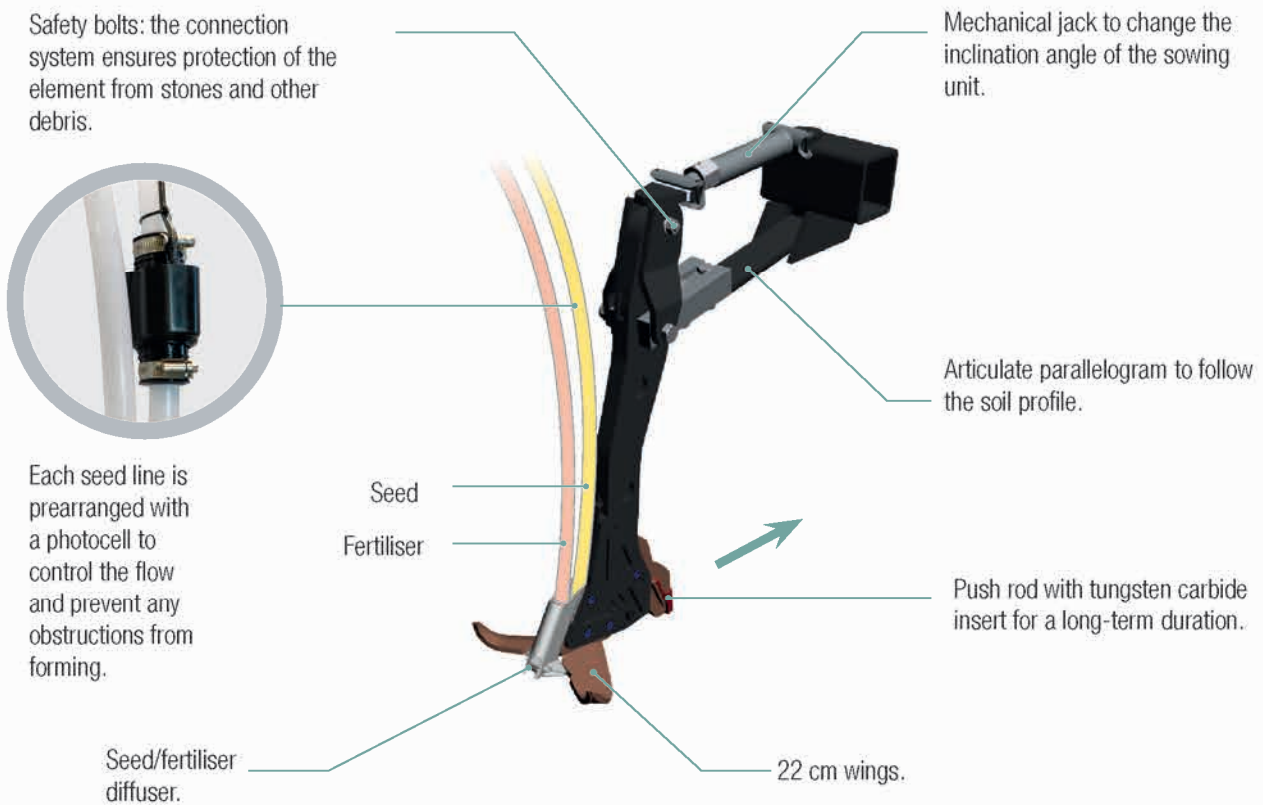

Sequence of introducing the sowing unit into the ground



Agronomic advantages of conservative agriculture through the AS-UST seeder

- Reduction of disturbance to the soil improving the structure of the terrain and increasing the mineralisation of the organic substance, facilitating the development of organisms and other benefits.
- Protection of the ground from erosion and no waste of mineral nutrients.
- Increase in the moisture retention capacity of the soil
- Nutrient elements available from the first stage of development with subsequently less need for fertilizers in the crop growing phase.
- Better water drainage and more rapid growth of crops
- Effective mechanical control of weeds



The planting unit with little wings (patented) allows getting a furrow by raising a layer of soil. This layer then drops off over the seed after the passage of the planting unit. This technology enables the seed to be planted without any contact with soil remains. Moreover, the little wings grant an efficient mechanical weeding.

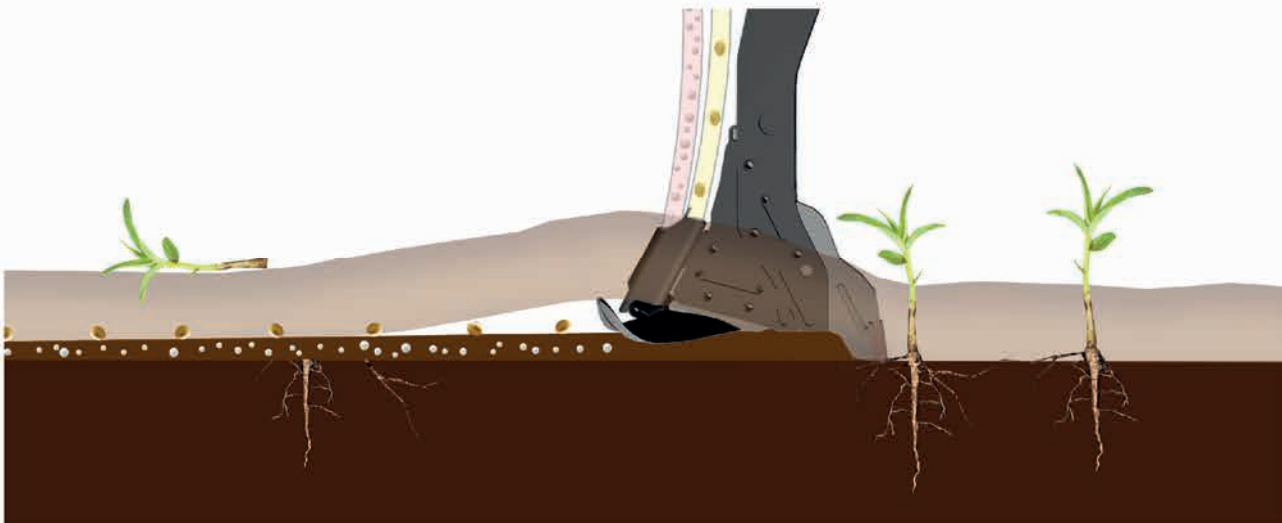

The sowing unit keeps the crop residue at the surface in order to prevent contact with the seed inside the furrow; effective mechanical control of weeds.

Advantages compared to no-till sowing with a double disc couler

Less power used and reduction in consumption

With the AS-UST seeder and at equal working widths, lower traction power is required thanks to the number of couler elements used. It is clear that less power translates into less consumption of fossil fuel.

Parts subject to wear

The disc seed planting system assembly subjects many working parts to wear and requires spare parts for correct machinery maintenance. Thanks to the simplicity of the construction of the AS-UST seeder couler element, only a few spare parts are required, all of which are reasonably priced.

In terms of agronomics

The no-till disc system which sows and/or cuts the crop residue with the subsequent mixing of the terrain together with seed planting limits the development of the root system and plant growth.

Row spacing available

The bilateral seed diffuser and the 30 cm distance between the centre points of the coulters makes different seed row spacing possible. Below are some examples.

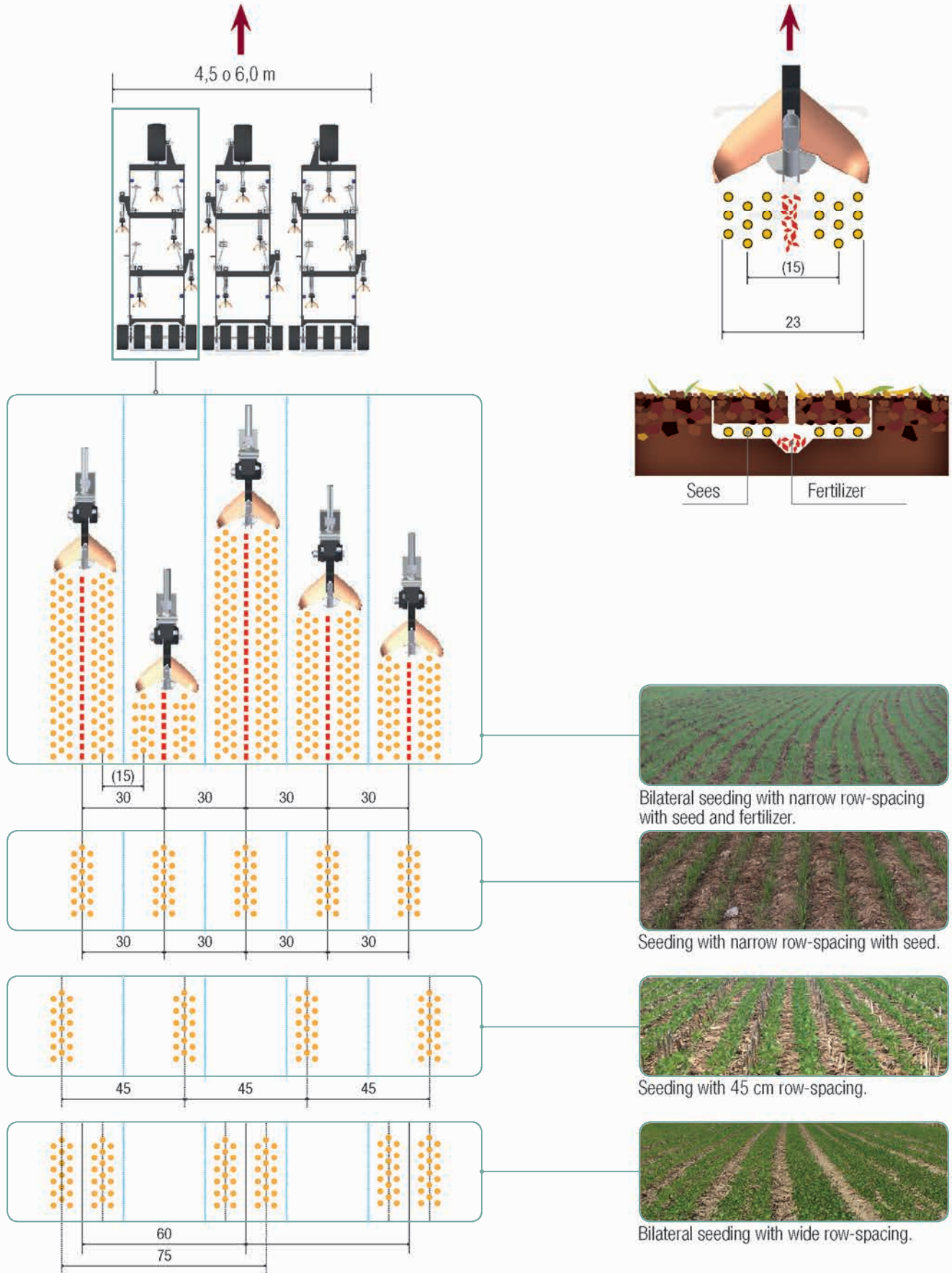

Version available with different row distances, obtained by the exclusion of outlets, planting metering units or planting units.

Financial advantages

Real comparisons of the test per unit/ha with the same tractor using different sowing methods

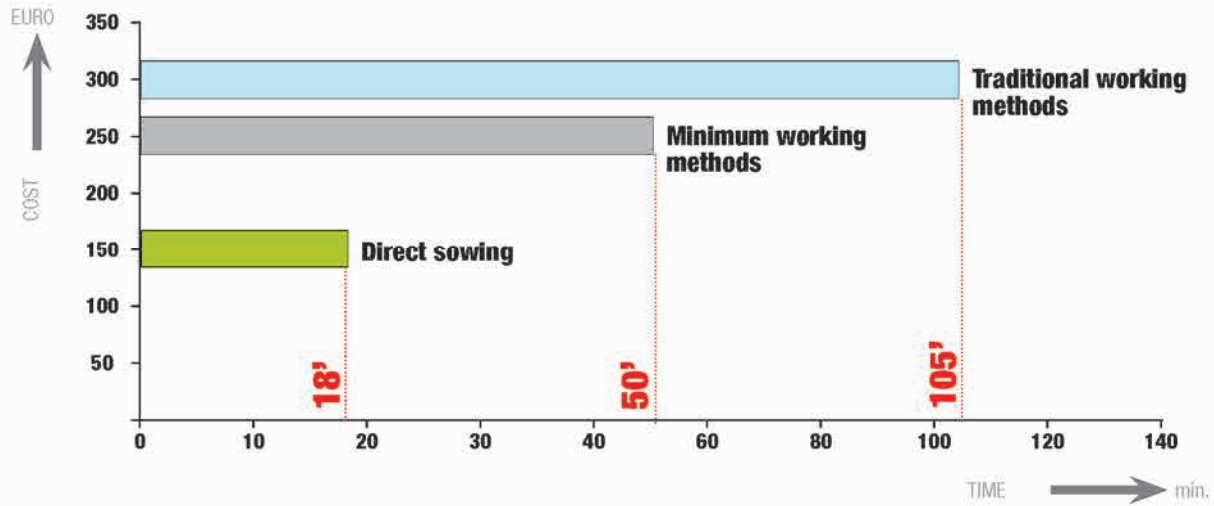

Traditional working methods
Combined ploughing, harrowing and planting, 3.0 m.



Minimum working methods
Preparation with cultivator and anchors of 3.0 m and sowing with pneumatic seeders of 4.5 m.



Direct sowing
Direct sowing with AS-UST of 4.5 m.



Financial benefits provided by the AS-UST seeder

Time

Time saved always translates into money, eliminating ploughing, harrowing, work with disc harrows and the preparation in general of the land for sowing means saving an average of 50% compared to traditional working methods and approximately 30% when compared to minimum working methods.

Spare parts

The AS-UST seeder has a maintenance cost per Ha which is extremely low thanks to the small number of parts which are subject to wear.

BIO Crops

The AS-UST no-till sowing which is also used for BIO crops facilitates the growth of the root system of specific plants.

Versatility

The versatility of the AS-UST allows most existing crops to be sown such as soya, cereals, forage, cover crop. For this reason it can be defined as a universal seeder.



PLANTING UNIT 8000-RS

Main Features

Suitable for planting either on a prepared soil or on a minimum tillage condition, 8000 - RS unit permits to maintain the preset seeding depth.

Characterized by a double disc opener with a diameter of 390 mm, it can work with crop residues on soil. Seeding depth control is obtained by two rubber wheels positioned close to the seed drop-off point. The articulated parallelogram guarantees a wide range of action of the planting unit. The rear furrow-covering rubber wheels can be adjusted in several ways to optimize results.

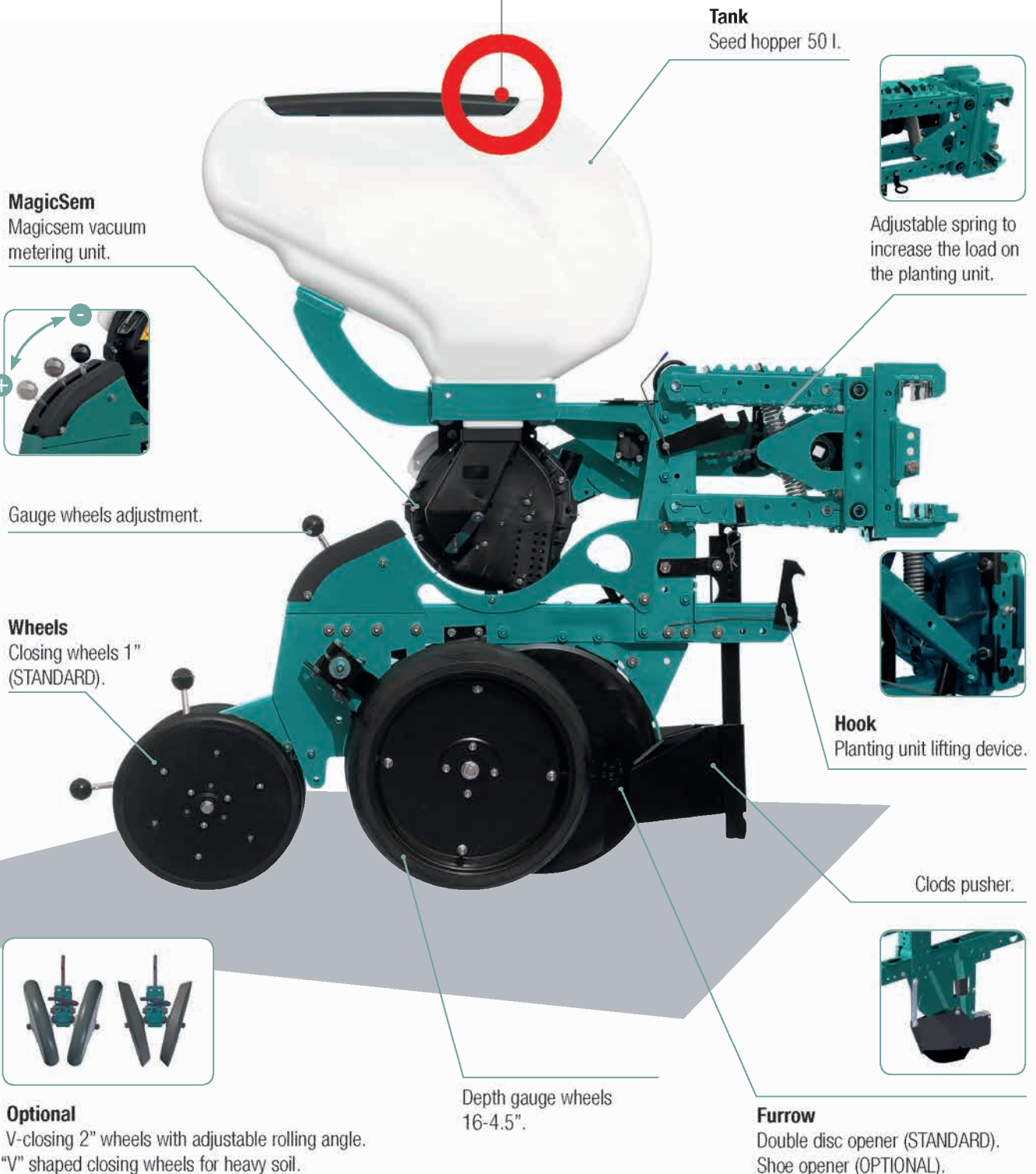

Tank
Seed hopper 50 l.

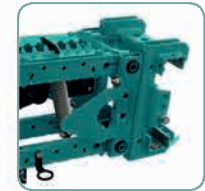

Adjustable spring to increase the load on the planting unit.

MagicSem
Magicsem vacuum metering unit.

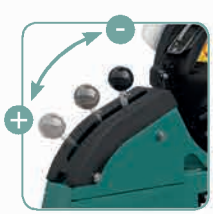

Gauge wheels adjustment.

Wheels
Closing wheels 1" (STANDARD).



Optional
V-closing 2" wheels with adjustable rolling angle. "V" shaped closing wheels for heavy soil.

Depth gauge wheels 16-4.5".



Hook
Planting unit lifting device.

Clods pusher.



Furrow
Double disc opener (STANDARD).
Shoe opener (OPTIONAL).



Depth gauge wheels

The side wheels on the planting unit move up and down to keep constant seeding depth. The depth can be adjusted using a handle mounted near the wheels.

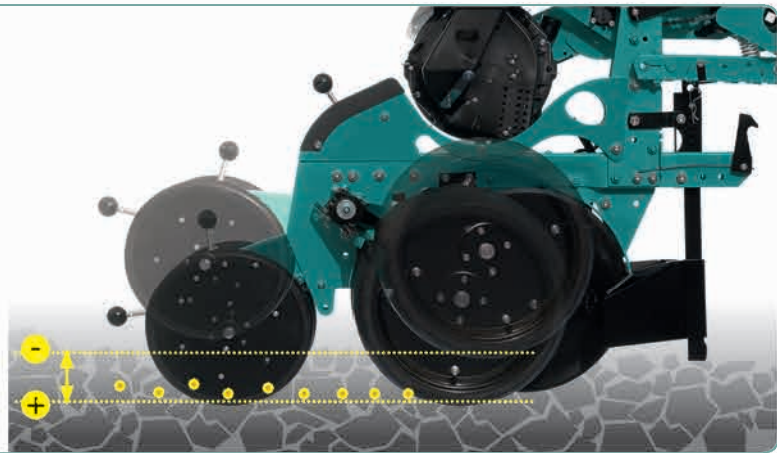

Closing wheels

Closing wheels pressure adjustment.



Wheels angle adjustment.



Spacing between closing wheels adjustment.



Ripper for direct seeding on light soil.



Row cleaner "trash wheel".



Front waved kit.



TURBO disc opener with fitting.



Extra spring-loading kit for planting unit.



Kit press wheel with in-between seed coverer.



In-between seed coverer.



Stainless steel or rubber seed press wheel.

Options

ARBOS configures its planters according to customer specific needs to the wide range of accessories available.

MS 8230

[MAIZE, SUNFLOWER, SOY, BEETROOT, OIL-SEED RAPE, SORGHUM]



- The MS 8230 is a highly versatile seed drill which can achieve reduced road widths, even with working widths of up to 6 metres, thanks to the hydraulic management of the EASY-SET movement system and folding tool bar.
- A system of interchangeable limit-stop rings allows the row spacing to be changed with ease.



TECHNICAL DATA

Type 8000 planting unit
Frame with folding wings and hydraulic Easy-Set device
Road width from 2.54, 3.0 and 3.20 metres
Safety device to prevent accidental tool bar opening
Three-point hitch
PTO 540 min-1
PTO shaft with 1" 3/8 Z6 free wheel (length 510 mm)
Vacuum gauge
Automatic hydraulic row marker
Centralised 21-speed gearbox
Range of seeding discs
Range of inter-row rings
Small seed expeller and partition
Conveyor for collection of residual seeds
Element lifting lever
Element movement lever
NOTES: Minimum 2 tractor hydraulic distributors



MS 8230 Hydraulic folding Easy-Set tool bar

MS 8230 planter is extremely versatile, allowing to reduce transport widths even for planters with a working width of 6 m, due to the hydraulic Easy-Set System and folding tool bar.

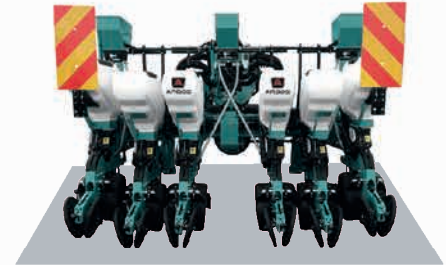
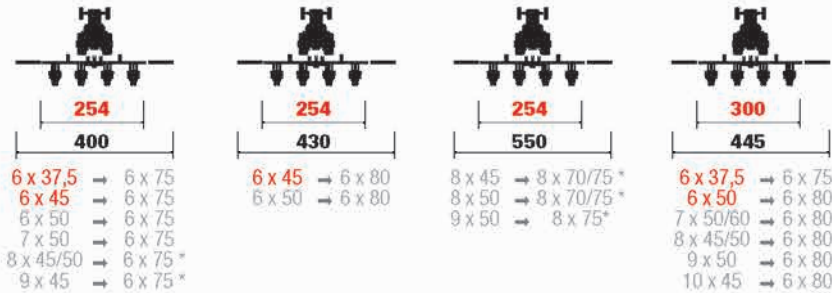

* only with narrow gauge wheels - mis. 16" x 2,5"

N° OF ROWS	ROW SPACING	TOOL BAR	WEIGHT		POWER REQUIRED	CAPACITY		
			BASE	FERTIL		SEED	MICRO	FERTIL
	(cm)	(cm)	(kg)		(hp)	(l)		
6	45-75	254/400	1040	1200	80-100	300	75	2 x 170
6	45-75	300/445	1100	1260	80-100	300	75	2 x 215
7	45-80	254/400	1140	1320	80-100	350	88	2 x 170
7	45-70	300/445	1190	1370	80-100	350	88	2 x 215

MS 8230 Hydraulic folding Easy-Set tool bar

MS 8230 planter is extremely versatile, allowing to reduce transport widths even for planters with a working width of 9 m, due to the hydraulic Easy-Set System and folding tool bar.

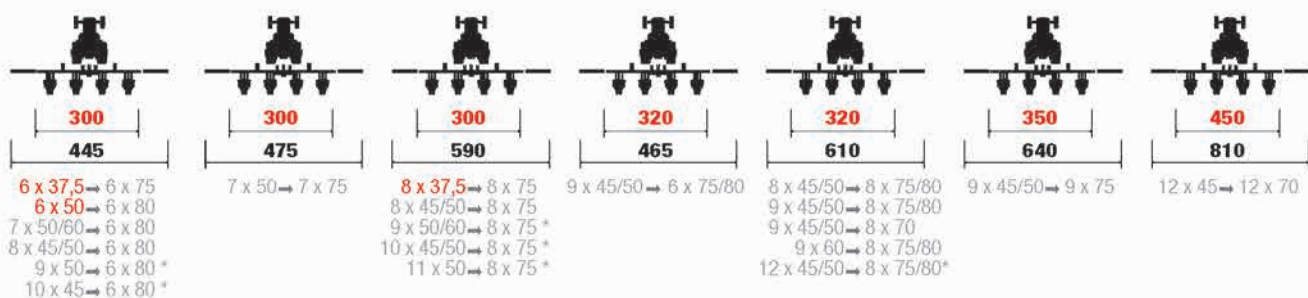

* only with narrow gauge wheels - mis. 16" x 2,5"

N° OF ROWS	ROW SPACING	TOOL BAR	WEIGHT		POWER REQUIRED	CAPACITY		
			BASE	FERTIL		SEED	MICRO	FERTIL
	(cm)	(cm)	(kg)		(hp)	(l)		
8	45-75	300/445	1280	1480	80-100	400	100	2 x 215
8	45-75	300/590	1330	1550	80-100	400	100	2 x 215
9	45-80	300/465	1370	-	80-100	450	113	-
8	45-80	320/610	1340	1560	80-100	400	100	2 x 215
9	45-80	320/610	1430	-	80-100	450	113	-
12	45-80	320/610	1700	-	90-110	600	150	-
12	45-70	450/810	2050	2550	120	600	150	1 x 1200

MS 8130 Telescopic tool bar

This vacuum precision planter with a hydraulic telescopic tool bar permits to switch directly from working position into transport position.

The planter is very compact and has a low overhanging weight.

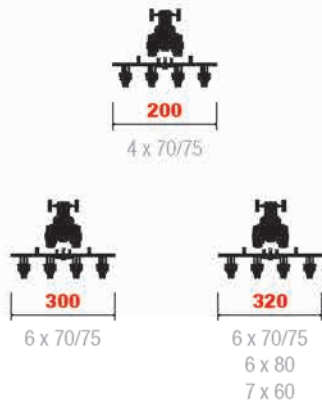

N° OF ROWS	ROW SPACING (cm)	TOOL BAR (cm)	WEIGHT (kg)		POWER REQUIRED (hp)	CAPACITY (l)		
			BASE	FERTIL		SEED	MICRO	FERTIL
4	70-75	200	680	860	60-80	200	50	2 x 170
6	70-75	300	950	1170	80-100	300	75	2 x 215
6	80	320	980	1200	80-100	300	75	2 x 215
7	60	320	1100	-	80-100	350	88	-



TWIN ROW VACUUM PRECISION PLANTERS



MS TWIN

Increasing production using the same surface area is now possible due to ARBOS's innovative twin row planter. The productive yield per hectare is increased by changing the sowing density and the plant genetic, using quincunx or "zig-zag" sowing. Despite that the equipment already in the company could be maintained, such as cultivators and collection bars, since the row spacing is the same as the one for maize (70-75 cm).

Planting Unit

MS TWIN is the twin row precision planting unit of the MS 8000 range, with double disc coulters, allowing the twin rows to sow using the quincunx technique. ARBOS MS TWIN unit allows a sowing distance of 22 cm between the twin rows.



Advantages

- The mounted units are aligned and not offset.
- No obstruction between the narrow gauge wheels.
- Little distance between the tool bar and the planting unit with subsequent lighter load on the lifter.
- Synchrony of the twin rows kept constant as the sowing distance varies.
- Possibility of excluding rows from sowing.

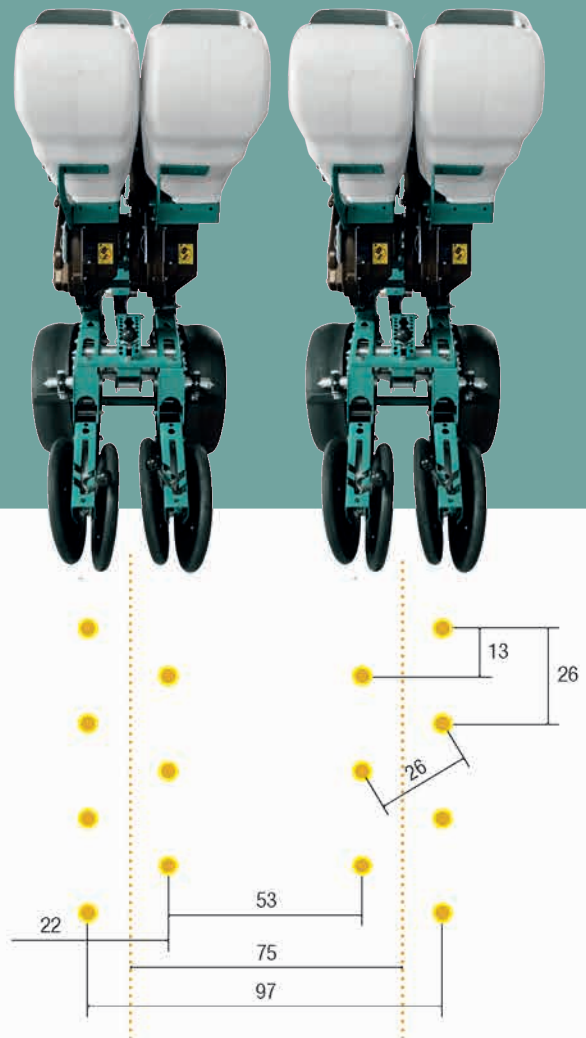

Investment 105,000 seeds/ha



MS TWIN Rigid tool bar Hydraulic vertical folding tool bar

MS TWIN is the twin row precision planting unit of the MS 8000 range, with double disc coupler, allowing the twin rows to sow using the quincunx technique. ARBOS MS TWIN unit allows a sowing distance of 22 cm between the twin rows. Also available with Easy-Set frame.

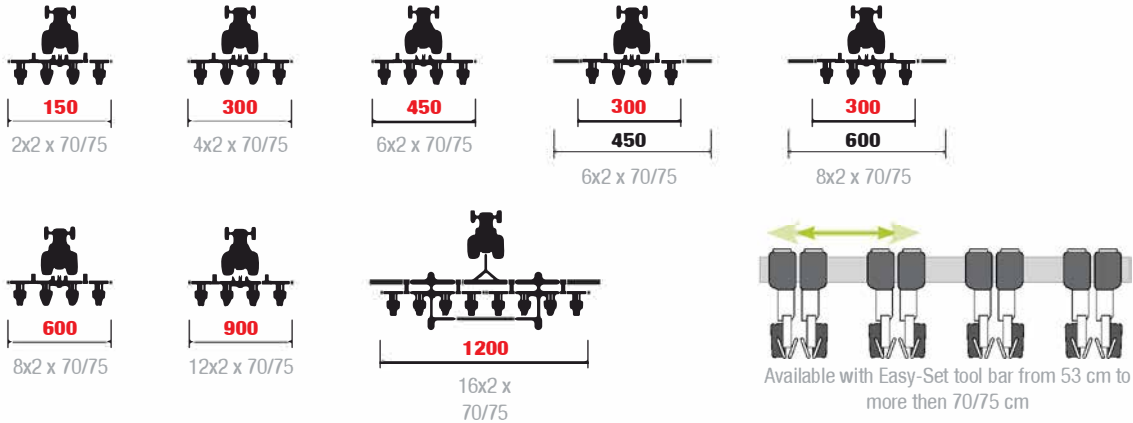

N° OF ROWS	ROW SPACING (cm)	TOOL BAR (cm)	WEIGHT (kg)		POWER REQUIRED (hp)	CAPACITY (l)		
			BASE	FERTIL		SEED	MICRO	FERTIL
4x2	53/70/75	300	1270	1450	100-110	400	100	2x215
6x2	53/70/75	450	1480	1760	110-120	600	150	2x215
6x2	53/70/75	300/450	1700	2050	120-130	420	150	2x215
8x2	53/70/75	600	1870	2250	130-140	800	200	2x700
12x2-S	53/70/75	900	3100	3650	140-150	1200	300	2x900
16x2-3XL	53/70/75	1200	9000	10000	200-250	1120	-	4x900

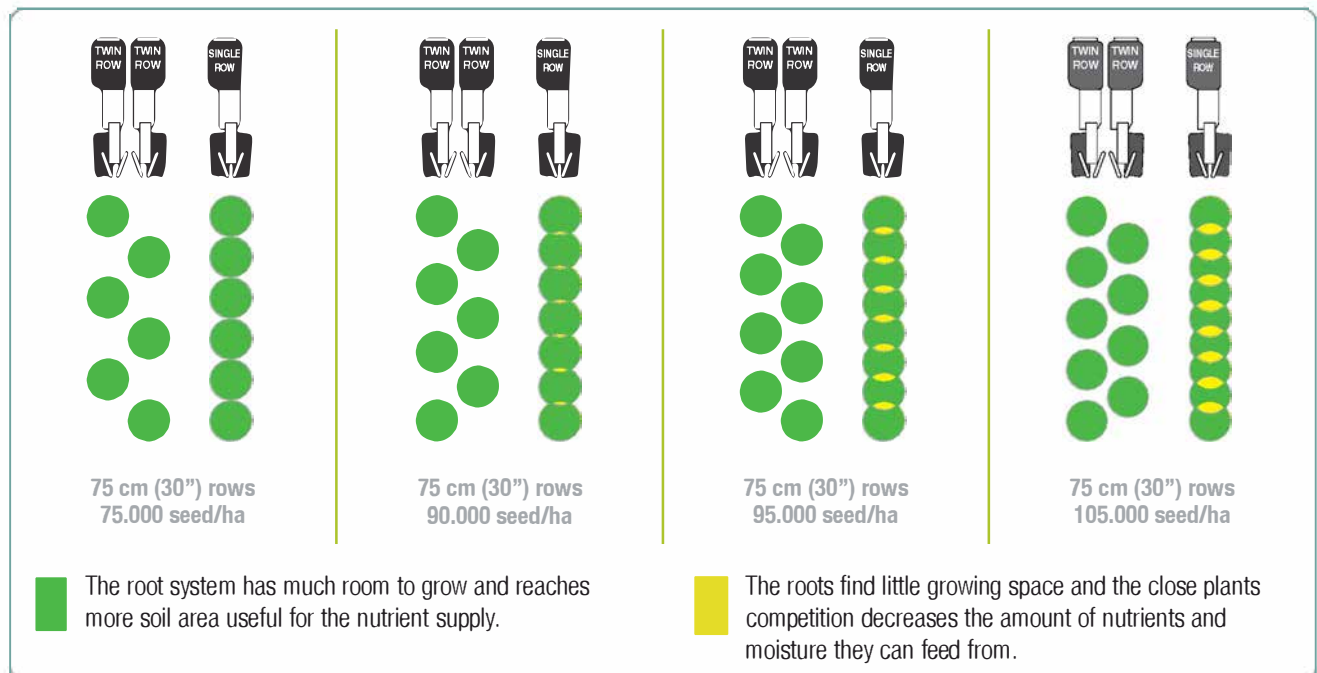

The table highlights the rooting area available in each row system



Your equipment remains the same

It is not necessary to adapt or change any equipment, ARBOS TWIN ROW planting unit, is done at 70 or 75 cm row spacing as for traditional crops.



ROW CROP CULTIVATOR



ROW CROP FERTILISER



CROP BOOM SPRAYER



SELF-PROPELLED SPRAYERS



FORAGE HARVESTER



COMBINE HARVESTER

Suitable to plant different crops

The ARBOS TWIN row planting sprouted for planting maize for seeding, soybeans, sunflowers, sorghum, oil seed rape, peanuts, rapeseed, cotton and also vegetables seed.



MAIZE



SOYBEANS



SUNFLOWERS



SORGHUM



OIL SEED RAPE



PEANUTS

SEED DRILL COMBINED WITH POWER HARROW

Pneumatic fan hydraulic drive, tractor dependent. The required continuous oil flow is 40 l/min with direct back-flow to the tank.

Seed tank
Large tank 1300 l, with two metering units.



PTO shaft with cam clutch (STANDARD).

MK
Power harrow model MK 150, MK 180, MK 270.

PAKER roller Ø 550 mm.

Available planting units



Single disc unit and anti-clogging device.



Single disc unit and depth gauge wheel.



Double disc unit and depth gauge wheel.



MSD 2.0 COMBI

MSD 2.0 COMBI seeder is particularly compact to reduce the strain on the lifter to a minimum, thereby reducing the ground compaction.

Combined ARBOS seeders allow you to prepare, level and cement the ground so as to be able to sow in one go.

This versatile machine reduces operating times.



Row marker

Hydraulic automatic row marker.(OPTIONAL).



Transport lights and reflection panels (STANDARD).

Loading platform.



Monitor X4

The 2 dispensers are powered by an electric motor and controlled by the ARBOS X4 sowing monitor. This monitor allows the seed density to be changed quickly, by setting the desired value. It also controls the sowing flow for each section. The tramline and seed exclusion functions are optional and can be integrated with the X4 monitor.

MK Power harrow

To ensure excellent performance even in difficult conditions where there are crop residues, our machines are designed and built with an optimal distance between the tooth-holder support and the harrow box.

This means a significant amount of residue and any stones can pass through easily, avoiding running into troublesome blockages.

The teeth on the harrow also ensure optimal penetration including in difficult ground, maintaining a constant working depth. The Paker roller with a diameter of 550 mm is suitable for medium-to-hard terrain; it is extremely versatile and can be used in combination with the seeder.

Three different rotating harrows: MK 150 with a single ball bearing for up to 150 hp, MK 180 for up to 180 hp and MK 270 for up to 270 hp, both with opposite tapered bearings.

As an optional, all harrows can come with a quick tooth-dismantling kit.



* standard - ** optional

MODEL	N° BLADES	DEPTH WORK (cm)	WIDTH (cm)		RPM ROTOR (min ⁻¹)		POWER REQUIRED POWER HARROW (hp)	WEIGHT POWER HARROW (kg)
			WORK	TRANSPORT	540	1000		
MK 150/300	24	10-30	294	300	348 *	362 **	100-150	1575
MK 180/300	24	10-30	294	300	350 **	359 *	100-180	1645
MK 180/350	28	10-30	342	348	350 **	359 *	110-180	1830
MK 270/300	24	10-32	294	300	-	365 *	150-270	1715
MK 270/350	28	10-32	342	348	-	365 *	150-270	1900

Power harrow accessories



Kit rigid track eradicator.



Kit NO STOP spring track eradicator.



Superfast equipment, power harrow.

MSD 2.0 COMBI Seed drill combined with power harrow

Pneumatic seed drill for sowing in rows in prepared or semi-prepared soil. The working width ranges from 3,0 m to 3,5 m with a standard row distance of 12,5 cm (other row distances available if requested). The 2 dispensers are powered by an electric motor and controlled by the ARBOS X4 sowing monitor. This monitor allows the seed density to be changed quickly, by setting the desired value. It also controls the sowing flow for each section. The tramline and seed exclusion functions are optional and can be integrated with the X4 monitor.



MODEL	N° OF ROWS	ROW SPACING	TOOL BAR	WEIGHT			POWER REQUIRED	CAPACITY
				DISC	DISC+DEPTH GAUGE WHEELS	D. DISCO+DEPTH GAUGE WHEELS		SEED
		(cm)	(cm)	(kg)			(hp)	(kg)
MSD-C 300/150	18	16.6	300	2220	2290	2330	130-170	1300
MSD-C 300/150	20	15.5	300	2250	2330	2380	130-170	1300
MSD-C 300/150	24	12.5	300	2320	2420	2470	130-170	1300
MSD-C 300/180	18	16.6	300	2290	2360	2400	140-190	1300
MSD-C 300/180	20	15.5	300	2320	2400	2450	140-190	1300
MSD-C 300/180	24	12.5	300	2390	2480	2540	140-190	1300
MSD-C 350/180	22	16.0	350	2560	2640	2700	160-210	1300
MSD-C 350/180	26	14.5	350	2630	2720	2790	160-210	1300
MSD-C 350/180	28	12.5	350	2660	2760	2830	160-210	1300
MSD-C 300/270	18	16.6	300	2370	2430	2470	180-250	1300
MSD-C 300/270	20	15.5	300	2400	2470	2520	180-250	1300
MSD-C 300/270	24	12.5	300	2460	2550	2610	180-250	1300
MSD-C 350/270	22	16.0	350	2650	2710	2770	200-270	1300
MSD-C 350/270	26	14.5	350	2700	2790	2860	200-270	1300
MSD-C 350/270	28	12.5	350	2750	2830	2900	200-270	1300



FERTILISERS



MMX Double disc mounted fertiliser spreader - 18/36 m

The MMX fertiliser spreader is a compact, accurate machine. It is used for distributing granular, powder and pellet chemical fertilisers. It reaches a spreading width of up to 36 m.

The spreader unit, nuts and bolts, and opening discs are made from stainless steel to prevent corrosion and prolong the life of the product.

The standard hydraulic opening mechanism allows one section (left or right) of the machine to be disabled; when spreading along a border, for example, just one section can be used.



MODEL	CAPACITY	SPREADING WIDTH	PTO	SIZE (AXBXC)	WEIGHT
	(l)	(m)	(r.p.m)	(cm)	(kg)
MMX 1200	1260	18/36	540	220 x 126 x 136	600
MMX 1800	1810	18/36	540	220 x 147 x 136	630
MMX 2400	2360	18/36	540	220 x 168 x 136	662
MMX 3000	3000	18/36	540	248 x 185 x 136	694
MMX 3600	3600	18/36	540	248 x 205 x 136	726
MMX 4200	4200	18/36	540	248 x 225 x 136	758

MMX Double disc mounted fertiliser spreader - 18/36 m

The MMX ELEKTRO fertiliser spreader is a compact, accurate machine. It is used for distributing granular, powder and pellet chemical fertilisers.

The ELEKTRO system allows you to adjust the opening of the dosing sections automatically, according to the tractor speed and the current flow characteristics of the mineral fertilisers used for fertilisation.

Due to automatic filtering, the 4 load cells calculate the different fertiliser characteristics extremely accurately and reliably, including when it's in motion.

MODEL	CAPACITY	SPREADING WIDTH	PTO	SIZE (AXBXC)	WEIGHT
	(L)	(m)	(r.p.m)	(cm)	(Kg)
MMX-E 1200	1260	18/36	540	220 x 126 x 136	600
MMX-E 1800	1810	18/36	540	220 x 147 x 136	630
MMX-E 2400	2360	18/36	540	220 x 168 x 136	662
MMX-E 3000	3000	18/36	540	248 x 185 x 136	694
MMX-E 3600	3600	18/36	540	248 x 205 x 136	726
MMX-E 4200	4200	18/36	540	248 x 225 x 136	758

MCA-W Double disc mounted fertiliser spreader - 10/18 m

The MCA-W fertiliser spreader is a compact, accurate machine. It is used for distributing granular, powder and pellet chemical fertilisers.

The particular shape of the hopper allows a max. clearance width of 1.10 meters, specifically for the fertilization of crops with row spacing with extremely narrow planting layout. The OPTIONAL adjustable conveyor allows spreading widths ranging from 2 to 5 m.

The spreader unit, nuts and bolts, and opening discs are made from stainless steel to prevent corrosion and prolong the life of the product. The standard hydraulic opening mechanism allows one section (left or right) of the machine to be disabled; when spreading along a border, for example, just one section can be used.



MODEL	CAPACITY (L)	WORKING WIDTH (m)	PTO (r.p.m)	SIZE (AXBXC)  (cm)	TANK		WEIGHT (kg)
					PAINTED	INOX	
MCA-W 600	590	10/18	540	110 x 98 x 133	•	•	187
MCA-W 800	830	10/18	540	110 x 118 x 133	•	•	202
MCA-W 1000	1010	10/18	540	110 x 138 x 133	•	•	217

MCA-W ELEKTRO Double disc mounted fertiliser spreader - 10/18m

The MCA-W ELEKTRO fertiliser spreader is a compact, accurate machine. It is used for distributing granular, powder and pellet chemical fertilisers.

The particular shape of the hopper allows a max. clearance width of 1.10 meters, specifically for the fertilization of crops with row spacing with extremely narrow planting layout.

The ELEKTRO system allows you to adjust the opening of the dosing sections automatically, according to the tractor speed and the current flow characteristics of the mineral fertilisers used for fertilisation. Due to automatic filtering, the 4 load cells calculate the different fertiliser characteristics extremely accurately and reliably, including when in motion.



MODEL	CAPACITY (L)	WORKING WIDTH (m)	PTO (r.p.m)	SIZE (AXBXC)  (cm)	WEIGHT (kg)
MCA-W E 600	590	10/18	540	110 x 98 x 133	192
MCA-W E 800	830	10/18	540	110 x 118 x 133	210
MCA-W E 1000	1010	10/18	540	110 x 138 x 133	230

SUBSOILER

The ARBOS ripper of the ROCK series has been designed and constructed to meet all user needs on particularly firm terrain and where crop residue is present.

The high-resistant steel used and the particular structure with bolted joints make the ROCK ripper suitable for heavy-duty working conditions.

Each anchor is equipped with a bolted safety device duly sized and a quick-release tip. It can also be equipped with deflectors to break up the terrain better.

The row spacing between the anchors can be easily modified to adapt to the needs of the most demanding operator.

The ROCK ripper can also be used in the version without wheels.

The rear rollers are equipped with parallelogram hydraulic movement which ensures quick and accurate adjustment of the working depth.

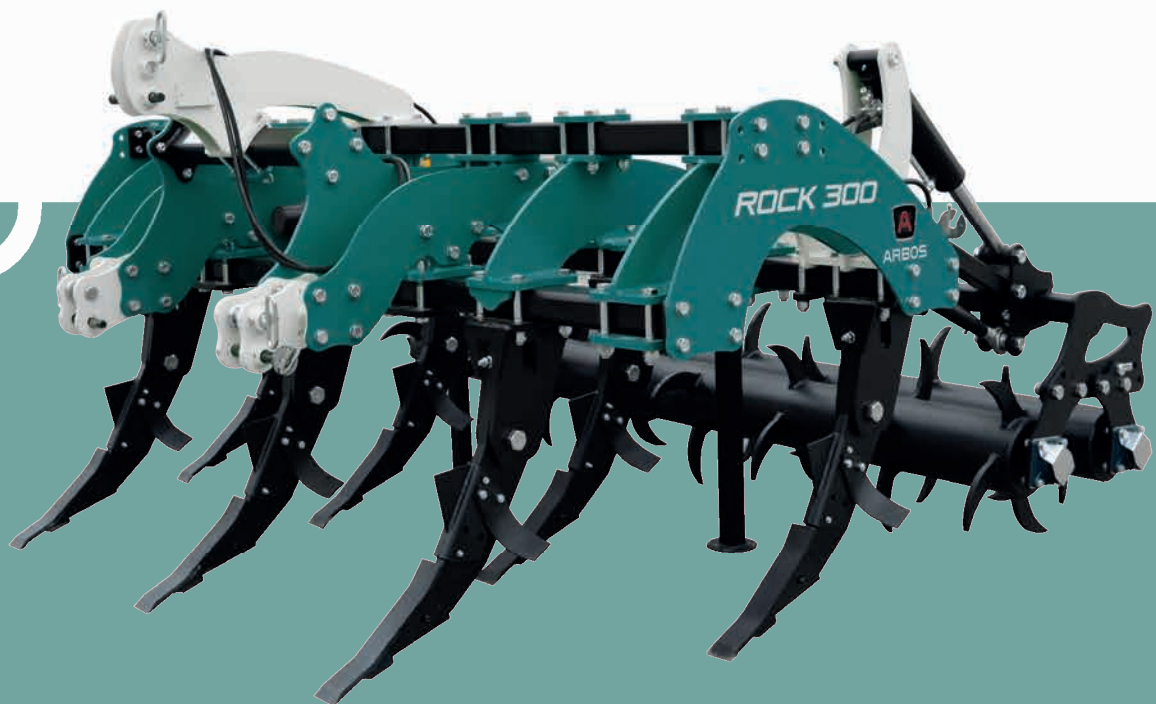

Optional



Standard Anchor



Blast Anchor



Wings Anchor



Support wheels



Manual strip



Hydraulic strip



**Double roller
2 x Ø 220 mm**



**Double roller
Ø 360 + Ø 220 mm**

Counter-rotating spike rollers

The particular architecture of the roller frame allows the operator to modify the centreline between the roller. This important technical solution allows the machine to be customised so that it adapts perfectly to all conditions of the terrain.

1. Hydraulic adjustment of the working depth
2. Mechanical adjustment of the roller distance
3. Mechanical adjustment of the roller alignment

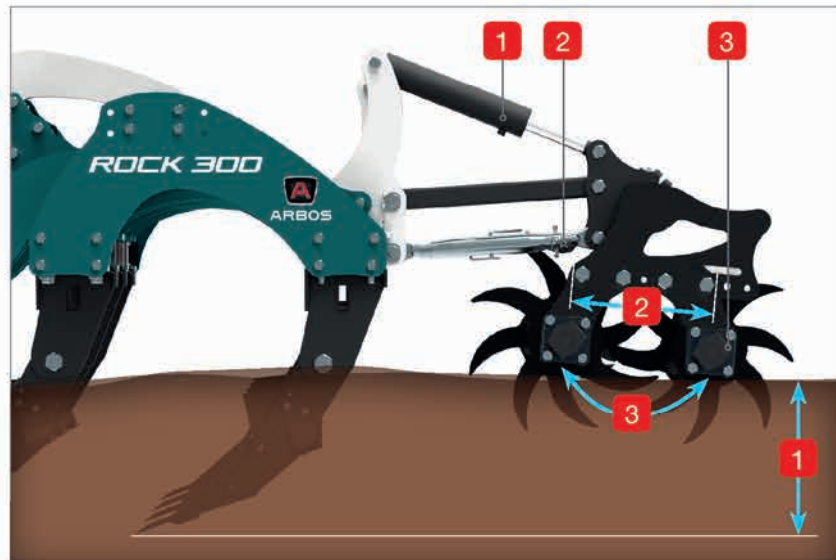

Deflectors

The steel deflectors with anti-wear treatment can be adjusted and set to one of two positions to adapt to all types of terrain.



Joints

Joints using a locking system with high-resistant bolts.

Anchors

The anchors are equipped with a bolted safety device.

Long Life Tips

The tips are in anti-wear steel and can be easily replaced thanks to a quick-fit disassembly system.

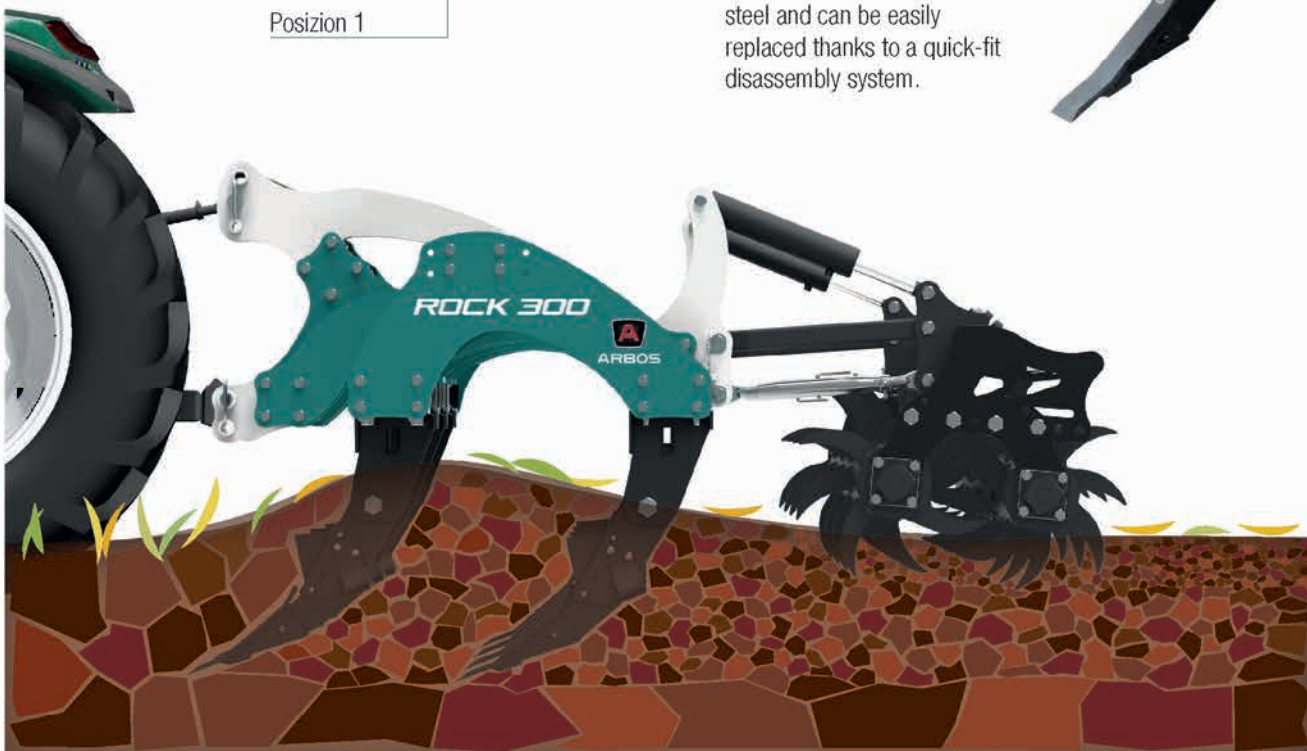
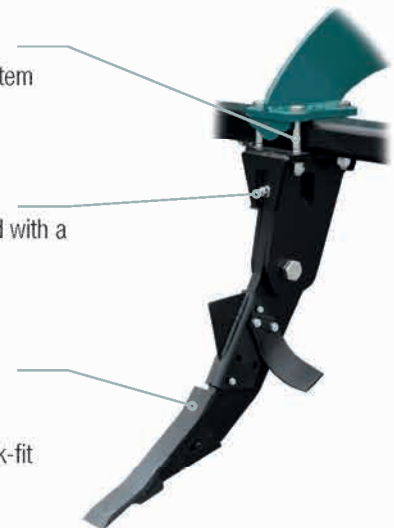

Anchors

Even in working conditions where there is a significant amount of crop residue in particularly firm terrain, the anchors do not compromise the excellent performance of the ROCK ripper. In fact, thanks to their considerable height from the ground and the distance between the anchor rows, duly sized, perfect mixing of the soil is guaranteed along with the free flow of the terrain inside the ripper without causing any obstructions even when working at maximum depth.

ROCK Subsoiler

The characteristics of the steel used and the particular structure with bolted joints make the ROCK ripper suitable for heavy-duty, intense working conditions. Each anchor is equipped with a bolted safety device and with a quick-release tip. It can also be equipped with breakers. The height of the ROCK M2 ripper frame from the ground is 78 cm.

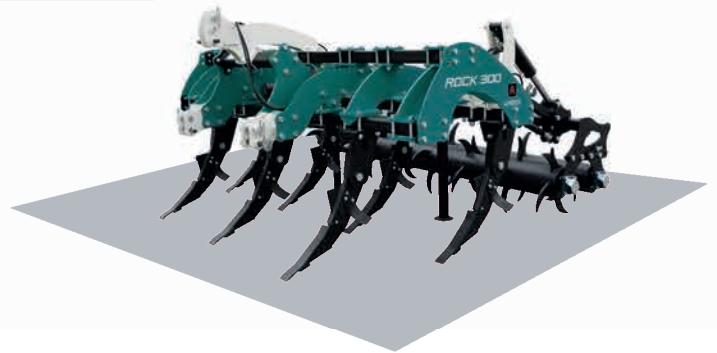

MODEL	N° OF RIPPERS	WORKING DEPTH	TOOL BAR	RIPPER DISTANCE	WEIGHT		POWER REQUIRED	
					BASE	ROLLER	BASE	MAX
		(cm)	(cm)	(cm)	(kg)		(hp)	
ROCK M2 250/5	5	55	250	80	940	1390	130-170	200
ROCK M2 250/7	7	55	250	80	1150	1600	150-220	250
ROCK M2 300/5	5	55	300	80	980	1480	130-170	200
ROCK M2 300/7	7	55	300	80	1170	1670	150-220	250

ROCK Subsoiler

The characteristics of the steel used and the particular structure with bolted joints make the ROCK ripper suitable for heavy-duty, intense working conditions. Each anchor is equipped with a bolted safety device and with a quick-release tip. It can also be equipped with breakers. The height of the ROCK M3 ripper frame from the ground is 92 cm.

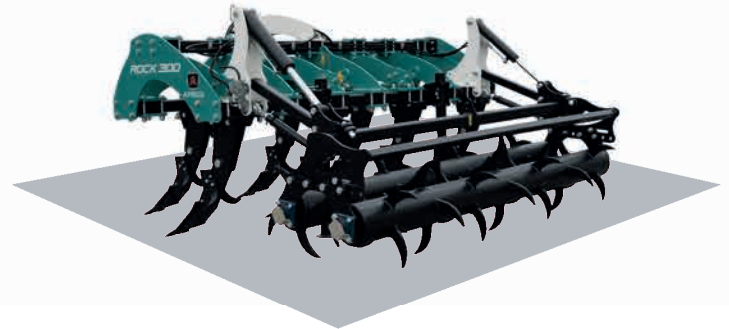

MODEL	N° OF RIPPERS	WORKING DEPTH	TOOL BAR	RIPPER DISTANCE	WEIGHT		POWER REQUIRED	
					BASE	ROLLER	BASE	MAX
		(cm)	(cm)	(cm)	(kg)		(hp)	
ROCK M3 250/5	5	65	250	87	1400	2040	150-250	280
ROCK M3 300/5	5	65	300	87	1440	2140	150-250	280
ROCK M3 300/7	7	65	300	87	1700	2400	200-370	400
ROCK M3 400/7	7	65	390	87	1740	2540	200-370	400
ROCK M3 400/9	9	65	390	87	2100	2900	250-400	420





ARBOS

ARBOS GROUP S.p.A. a s.u.
Via Canale, 3 - 41012 Migliarina di Carpi - Modena - Italy • T +39 0522 640111 - F +39 0522 699002
arbos.com